

# Wireflow

Design by Arik Levy

Crafted of black, electrical cables, Volumetric's airy, three-dimensional outline lends it the feeling of being at once present and absent. The geometric volumes are tipped with LED light terminals in a contemporary take on the traditional chandelier.



Each project is unique. Visit [vibia.com](http://vibia.com) and chose among multiple compositions designed and adapted to your project needs.

Personalise your own Wireflow composition quick and easy at [vibia.com](http://vibia.com)

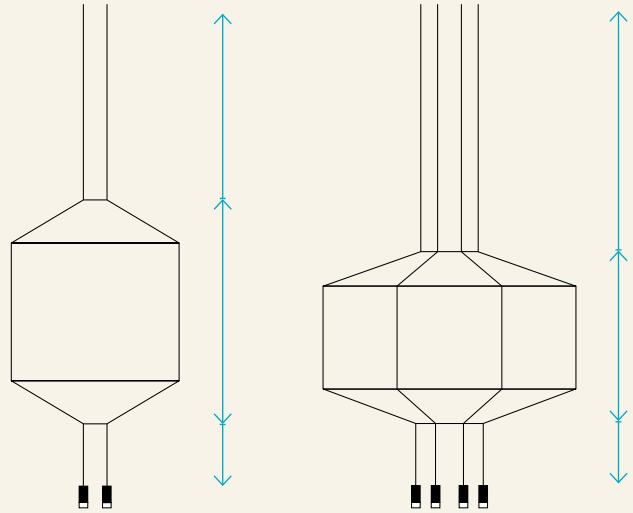

Pressed-glass diffuser.  
 \*Without pressed-glass diffuser.

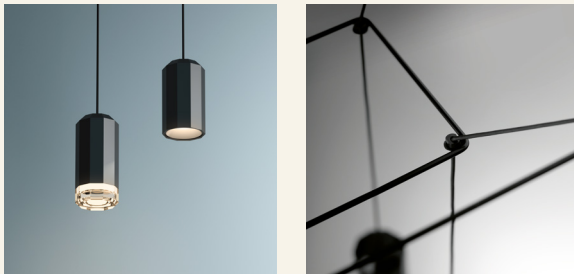

0299

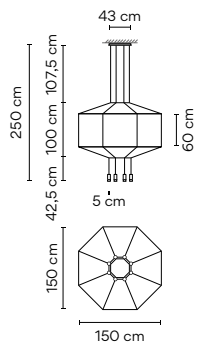

Finishes  
 ● 04/ \_\_ Black (RAL 9005)

LED temperature colour  
 /1 \_ 2700 K [D] CRI >90 3880 lm 121 lm/W  
 /2 \_ 3000 K [E] CRI >90 3880 lm 121 lm/W  
 /3 \_ 3500 K [E] CRI >90 4002,4 lm 125,1 lm/W

Control  
 0299 \_\_ / \_ A DALI-2, 1-10V, Push  
 0299 \_\_ / \_ Z Casambi

Materials  
 Diffuser: Pressed-glass. Horizontal rods: Steel.  
 Body: Aluminum Canopy: Steel.

Light Source and electronics  
 8 x LED 4,5 W 350 mA  
 Constant Current 350 mA  
 110-240V 50/60Hz

Packaging  
 2 Boxes  
 Total Vol 0,3245 m³  
 Gross weight 20,6 Kg Net weight 9,6 Kg

Notes  
 Pressed-glass diffuser.

Configuration layout at [vibia.com](http://vibia.com)  
 Min. quantity, upcharge and extra lead time apply



0300

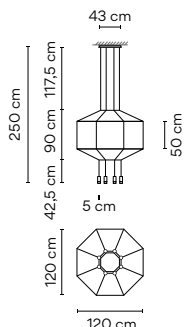

<p><b>Finishes</b></p> <ul style="list-style-type: none"> <li>● <b>04/</b> __ Black (RAL 9005)</li> </ul>	<p><b>LED temperature colour</b></p> <ul style="list-style-type: none"> <li><b>/1</b> _ 2700 K  CRI &gt;90 3880 lm 121 lm/W</li> <li><b>/2</b> _ 3000 K  CRI &gt;90 3880 lm 121 lm/W</li> <li><b>/3</b> _ 3500 K  CRI &gt;90 4002,4 lm 125,1 lm/W</li> </ul>	<p><b>Control</b></p> <p><b>0300</b> __ / __ <b>A</b> DALI-2, 1-10V, Push</p> <hr/> <p><b>0300</b> __ / __ <b>Z</b> Casambi</p>
---	--	---

<p><b>Materials</b></p> <p>Diffuser: Pressed-glass. Horizontal rods: Steel. Body: Aluminum Canopy: Steel.</p> <p><b>Light Source and electronics</b></p> <p>8 x LED 4,5 W 350 mA Constant Current 350 mA 110-240V 50/60Hz</p>	<p><b>Packaging</b></p> <p>2 Boxes Total Vol 0,3246 m<sup>3</sup> Gross weight 19,95 Kg Net weight 8,95 Kg</p> <p><b>Notes</b></p> <p>Pressed-glass diffuser.</p> <p><b>Configuration layout at vibia.com</b> Min. quantity, upcharge and extra lead time apply</p>
---	---



0301

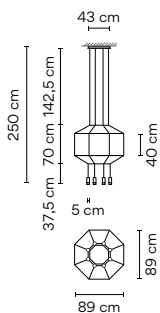

<p><b>Finishes</b></p> <ul style="list-style-type: none"> <li>● <b>04/</b> __ Black (RAL 9005)</li> </ul>	<p><b>LED temperature colour</b></p> <ul style="list-style-type: none"> <li><b>/1</b> _ 2700 K  CRI &gt;90 3880 lm 121 lm/W</li> <li><b>/2</b> _ 3000 K  CRI &gt;90 3880 lm 121 lm/W</li> <li><b>/3</b> _ 3500 K  CRI &gt;90 4002,4 lm 125,1 lm/W</li> </ul>	<p><b>Control</b></p> <p><b>0301</b> __ / __ <b>A</b> DALI-2, 1-10V, Push</p> <hr/> <p><b>0301</b> __ / __ <b>Z</b> Casambi</p>
---	--	---

<p><b>Materials</b></p> <p>Diffuser: Pressed-glass. Horizontal rods: Steel. Body: Aluminum Canopy: Steel.</p> <p><b>Light Source and electronics</b></p> <p>8 x LED 4,5 W 350 mA Constant Current 350 mA 110-240V 50/60Hz</p>	<p><b>Packaging</b></p> <p>2 Boxes Total Vol 0,2100 m<sup>3</sup> Gross weight 17,75 Kg Net weight 8,75 Kg</p> <p><b>Notes</b></p> <p>Pressed-glass diffuser.</p> <p><b>Configuration layout at vibia.com</b> Min. quantity, upcharge and extra lead time apply.</p>
---	--



0302

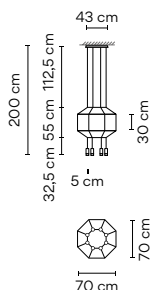

<p><b>Finishes</b></p> <ul style="list-style-type: none"> <li>● <b>04/</b> __ Black (RAL 9005)</li> </ul>	<p><b>LED temperature colour</b></p> <ul style="list-style-type: none"> <li><b>/1</b> _ 2700 K  CRI &gt;90 3880 lm 121 lm/W</li> <li><b>/2</b> _ 3000 K  CRI &gt;90 3880 lm 121 lm/W</li> <li><b>/3</b> _ 3500 K  CRI &gt;90 4002,4 lm 125,1 lm/W</li> </ul>	<p><b>Control</b></p> <p><b>0302</b> __ / __ <b>A</b> DALI-2, 1-10V, Push</p> <hr/> <p><b>0302</b> __ / __ <b>Z</b> Casambi</p>
---	--	---

<p><b>Materials</b></p> <p>Diffuser: Pressed-glass. Horizontal rods: Steel. Body: Aluminum Canopy: Steel.</p> <p><b>Light Source and electronics</b></p> <p>8 x LED 4,5 W 350 mA Constant Current 350 mA 110-240V 50/60Hz</p>	<p><b>Packaging</b></p> <p>2 Boxes Total Vol 0,1558 m<sup>3</sup> Gross weight 14,6 Kg Net weight 8,6 Kg</p> <p><b>Notes</b></p> <p>Pressed-glass diffuser.</p> <p><b>Configuration layout at vibia.com</b> Min. quantity, upcharge and extra lead time apply.</p>
---	--



0303

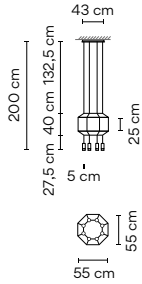

Finishes  
 ● 04/ \_ \_ Black (RAL 9005)

LED temperature colour  
 /1 \_ 2700 K [D] CRI >90 3880 lm 121 lm/W  
 /2 \_ 3000 K [E] CRI >90 3880 lm 121 lm/W  
 /3 \_ 3500 K [E] CRI >90 4002,4 lm 125,1 lm/W

Control  
 0303 \_ \_ / \_ A DALI-2, 1-10V, Push  
 0303 \_ \_ / \_ Z Casambi

Materials  
 Diffuser: Pressed-glass. Horizontal rods: Steel.  
 Body: Aluminum Canopy: Steel.

Light Source and electronics  
 8 x LED 4,5 W 350 mA  
 Constant Current 350 mA  
 110-240V 50/60Hz

Packaging  
 2 Boxes  
 Total Vol 0,1558 m³  
 Gross weight 13 Kg Net weight 8,5 Kg

Notes  
 Pressed-glass diffuser.  
**Configuration layout at vibia.com**  
 Min. quantity, upcharge and extra lead time apply.



0304

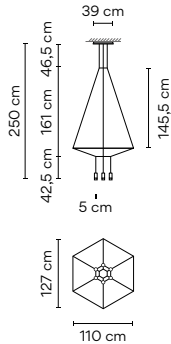

Finishes  
 ● 04/ \_ \_ Black (RAL 9005)

LED temperature colour  
 /1 \_ 2700 K [D] CRI >90 2910 lm 121 lm/W  
 /2 \_ 3000 K [E] CRI >90 2910 lm 121 lm/W  
 /3 \_ 3500 K [E] CRI >90 3001,8 lm 125,1 lm/W

Control  
 0304 \_ \_ / \_ A DALI-2, 1-10V, Push  
 0304 \_ \_ / \_ Z Casambi

Materials  
 Diffuser: Pressed-glass. Horizontal rods: Steel.  
 Body: Aluminum Canopy: Steel.

Light Source and electronics  
 6 x LED 4,5W 350 mA  
 Constant Current 350 mA  
 110-240V 50/60Hz

Packaging  
 2 Boxes  
 Total Vol 0,3245 m³  
 Gross weight 15,55 Kg Net weight 5,65 Kg

Notes  
 Pressed-glass diffuser.  
**Configuration layout at vibia.com**  
 Min. quantity, upcharge and extra lead time apply.

UNTIL STOCK RUNS OUT



0305

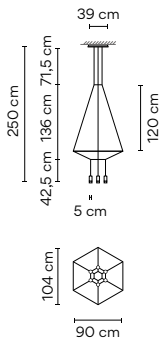

Finishes  
 ● 04/ \_ \_ Black (RAL 9005)

LED temperature colour  
 /1 \_ 2700 K [D] CRI >90 2910 lm 121 lm/W  
 /2 \_ 3000 K [E] CRI >90 2910 lm 121 lm/W  
 /3 \_ 3500 K [E] CRI >90 3001,8 lm 125,1 lm/W

Control  
 0305 \_ \_ / \_ A DALI-2, 1-10V, Push  
 0305 \_ \_ / \_ Z Casambi

Materials  
 Diffuser: Pressed-glass. Horizontal rods: Steel.  
 Body: Aluminum Canopy: Steel.

Light Source and electronics  
 6 x LED 4,5W 350 mA  
 Constant Current 350 mA  
 110-240V 50/60Hz

Packaging  
 2 Boxes  
 Total Vol 0,2100 m³  
 Gross weight 13,2 Kg Net weight 3,5 Kg

Notes  
 Pressed-glass diffuser.  
**Configuration layout at vibia.com**  
 Min. quantity, upcharge and extra lead time apply.

UNTIL STOCK RUNS OUT



0306

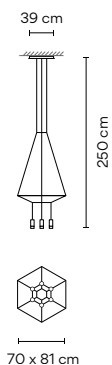

<b>Finishes</b> ● <b>04/</b> __ Black (RAL 9005)	<b>LED temperature colour</b> /1 _ 2700 K <b>D</b> CRI >90 2910 lm 121 lm/W
	/2 _ 3000 K <b>E</b> CRI >90 2910 lm 121 lm/W
	/3 _ 3500 K <b>E</b> CRI >90 3001,8 lm 125,1 lm/W

**Control**  
**0306** \_\_ / \_\_ A  
 DALI-2, 1-10V, Push  
**0306** \_\_ / \_\_ Z  
 Casambi

**Materials**  
 Diffuser: Pressed-glass. Horizontal rods: Steel.  
 Body: Aluminum Canopy: Steel.

**Light Source and electronics**  
 6 x LED 4,5W 350 mA  
 Constant Current 350 mA  
 110-240V 50/60Hz

**Packaging**  
 2 Boxes  
 Total Vol 0,2100 m<sup>3</sup>  
 Gross weight 13,1 Kg Net weight 5,2 Kg

**Notes**  
 Pressed-glass diffuser.  
**Configuration layout at vibia.com**  
 Min. quantity, upcharge and extra lead time apply.

**UNTIL STOCK RUNS OUT**



0307

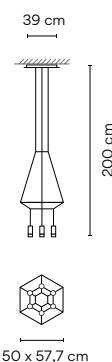

<b>Finishes</b> ● <b>04/</b> __ Black (RAL 9005)	<b>LED temperature colour</b> /1 _ 2700 K <b>D</b> CRI >90 2910 lm 121 lm/W
	/2 _ 3000 K <b>E</b> CRI >90 2910 lm 121 lm/W
	/3 _ 3500 K <b>E</b> CRI >90 3001,8 lm 125,1 lm/W

**Control**  
**0307** \_\_ / \_\_ A  
 DALI-2, 1-10V, Push  
**0307** \_\_ / \_\_ Z  
 Casambi

**Materials**  
 Diffuser: Pressed-glass. Horizontal rods: Steel.  
 Body: Aluminum Canopy: Steel.

**Light Source and electronics**  
 6 x LED 4,5W 350mA  
 Constant Current 350 mA  
 110-240V 50/60Hz

**Packaging**  
 2 Boxes  
 Total Vol 0,1558 m<sup>3</sup>  
 Gross weight 10 Kg Net weight 5,1 Kg

**Notes**  
 Pressed-glass diffuser.  
**Configuration layout at vibia.com**  
 Min. quantity, upcharge and extra lead time apply.

**UNTIL STOCK RUNS OUT**



0308

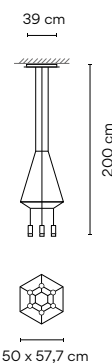

<b>Finishes</b> ● <b>04/</b> __ Black (RAL 9005)	<b>LED temperature colour</b> /1 _ 2700 K <b>D</b> CRI >90 2910 lm 121 lm/W
	/2 _ 3000 K <b>E</b> CRI >90 2910 lm 121 lm/W
	/3 _ 3500 K <b>E</b> CRI >90 3001,8 lm 125,1 lm/W

**Control**  
**0308** \_\_ / \_\_ A  
 DALI-2, 1-10V, Push  
**0308** \_\_ / \_\_ Z  
 Casambi

**Materials**  
 Diffuser: Pressed-glass. Horizontal rods: Steel.  
 Body: Aluminum Canopy: Steel.

**Light Source and electronics**  
 6 x LED 4,5W 350mA  
 Constant Current 350 mA  
 110-240V 50/60Hz

**Packaging**  
 2 Boxes  
 Total Vol 0,1238 m<sup>3</sup>  
 Gross weight 8,4 Kg Net weight 5 Kg

**Notes**  
 Pressed-glass diffuser.  
**Configuration layout at vibia.com**  
 Min. quantity, upcharge and extra lead time apply.

**UNTIL STOCK RUNS OUT**



0309

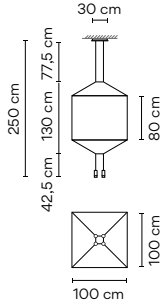

Finishes  
 ● 04/ \_\_ Black (RAL 9005)

LED temperature colour  
 /1 2700 K **D** CRI >90 1940 lm 121 lm/W  
 /2 3000 K **E** CRI >90 1940 lm 121 lm/W  
 /3 3500 K **E** CRI >90 2001,2 lm 125,1 lm/W

Control  
 0309 \_\_ / \_ A DALI-2, 1-10V, Push  
 0309 \_\_ / \_ Z Casambi

Materials  
 Diffuser: Pressed-glass. Horizontal rods: Steel.  
 Body: Aluminum Canopy: Steel.

Light Source and electronics  
 4 x LED 4,5 W 350 mA  
 Constant Current 350 mA  
 110-240V 50/60Hz

Packaging  
 2 Boxes  
 Total Vol 0,2100 m³  
 Gross weight 12,3 Kg Net weight 5,3 Kg

Notes  
 Pressed-glass diffuser.  
**Configuration layout at vibia.com**  
 Min. quantity, upcharge and extra lead time apply.



0310

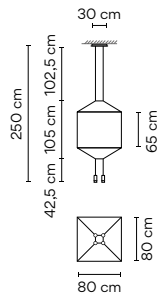

Finishes  
 ● 04/ \_\_ Black (RAL 9005)

LED temperature colour  
 /1 2700 K **D** CRI >90 1940 lm 121 lm/W  
 /2 3000 K **E** CRI >90 1940 lm 121 lm/W  
 /3 3500 K **E** CRI >90 2001,2 lm 125,1 lm/W

Control  
 0310 \_\_ / \_ A DALI-2, 1-10V, Push  
 0310 \_\_ / \_ Z Casambi

Materials  
 Diffuser: Pressed-glass. Horizontal rods: Steel.  
 Body: Aluminum Canopy: Steel.

Light Source and electronics  
 4 x LED 4,5 W 350 mA  
 Constant Current 350 mA  
 110-240V 50/60Hz

Packaging  
 2 Boxes  
 Total Vol 0,2100 m³  
 Gross weight 11,8 Kg Net weight 4,8 Kg

Notes  
 Pressed-glass diffuser.  
**Configuration layout at vibia.com**  
 Min. quantity, upcharge and extra lead time apply.



0311

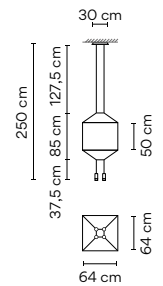

Finishes  
 ● 04/ \_\_ Black (RAL 9005)

LED temperature colour  
 /1 2700 K **D** CRI >90 1940 lm 121 lm/W  
 /2 3000 K **E** CRI >90 1940 lm 121 lm/W  
 /3 3500 K **E** CRI >90 2001,2 lm 125,1 lm/W

Control  
 0311 \_\_ / \_ A DALI-2, 1-10V, Push  
 0311 \_\_ / \_ Z Casambi

Materials  
 Diffuser: Pressed-glass. Horizontal rods: Steel.  
 Body: Aluminum Canopy: Steel.

Light Source and electronics  
 4 x LED 4,5 W 350 mA  
 Constant Current 350 mA  
 110-240V 50/60Hz

Packaging  
 2 Boxes  
 Total Vol 0,1558 m³  
 Gross weight 8,7 Kg Net weight 4,7 Kg

Notes  
 Pressed-glass diffuser.  
**Configuration layout at vibia.com**  
 Min. quantity, upcharge and extra lead time apply.



0312

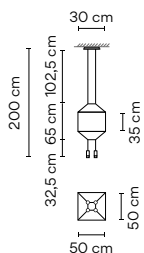

<p><b>Finishes</b></p> <ul style="list-style-type: none"> <li>● <b>04/ __ Black</b> (RAL 9005)</li> </ul>	<p><b>LED temperature colour</b></p> <ul style="list-style-type: none"> <li>/1 _ 2700 K <b>D</b> → CRI &gt;90 1940 lm 121 lm/W</li> <li>/2 _ 3000 K <b>E</b> → CRI &gt;90 1940 lm 121 lm/W</li> <li>/3 _ 3500 K <b>E</b> → CRI &gt;90 2001,2 lm 125,1 lm/W</li> </ul>	<p><b>Control</b></p> <p><b>0312 __ / _ A</b> DALI-2, 1-10V, Push</p> <hr/> <p><b>0312 __ / _ Z</b> Casambi</p>
---	---	---

<p><b>Materials</b></p> <p>Diffuser: Pressed-glass. Horizontal rods: Steel. Body: Aluminum Canopy: Steel.</p> <p><b>Light Source and electronics</b></p> <p>8 x LED 4,5 W 350 mA Constant Current 350 mA 110-240V 50/60Hz</p>	<p><b>Packaging</b></p> <p>2 Boxes Total Vol 0,1558 m<sup>3</sup> Gross weight 8,6 Kg Net weight 4,6 Kg</p> <p><b>Notes</b></p> <p>Pressed-glass diffuser.</p> <p><b>Configuration layout at vibia.com</b> Min. quantity, upcharge and extra lead time apply</p>
---	--



0313

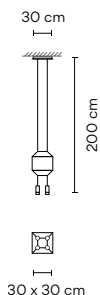

<p><b>Finishes</b></p> <ul style="list-style-type: none"> <li>● <b>04/ __ Black</b> (RAL 9005)</li> </ul>	<p><b>LED temperature colour</b></p> <ul style="list-style-type: none"> <li>/1 _ 2700 K <b>D</b> → CRI &gt;80 1961 lm 109 lm/W</li> </ul>	<p><b>Control</b></p> <p><b>0313 __ / _ A</b> DALI-2, 1-10V, Push</p> <hr/> <p><b>0313 __ / _ Z</b> Casambi</p>
---	---	---

<p><b>Materials</b></p> <p>Diffuser: Pressed-glass. Horizontal rods: Steel. Body: Aluminum Canopy: Steel.</p> <p><b>Light Source and electronics</b></p> <p>4 x LED 4,5 W 350 mA Constant Current 350 mA 110-240V 50/60Hz</p>	<p><b>Packaging</b></p> <p>2 Boxes Total Vol 0,1238 m<sup>3</sup> Gross weight 7 Kg Net weight 4,5 Kg</p> <p><b>Notes</b></p> <p>Pressed-glass diffuser.</p> <p><b>Configuration layout at vibia.com</b> Min. quantity, upcharge and extra lead time apply.</p>
---	---



0399

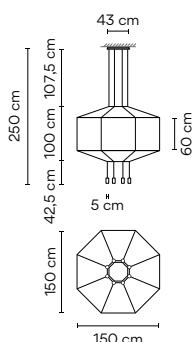

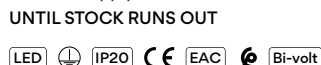

<p><b>Finishes</b></p> <ul style="list-style-type: none"> <li>● <b>04/ __ Black</b> (RAL 9005)</li> </ul>	<p><b>LED temperature colour</b></p> <ul style="list-style-type: none"> <li>/1 _ 2700 K <b>D</b> → CRI &gt;90 3880 lm 121 lm/W</li> </ul>	<p><b>Control</b></p> <p><b>0399 __ / _ A</b> DALI-2, 1-10V, Push</p> <hr/> <p><b>0399 __ / _ Z</b> Casambi</p>
---	---	---

<p><b>Materials</b></p> <p>Diffuser: Polycarbonate. Horizontal rods: Steel. Body: Aluminum Canopy: Steel.</p> <p><b>Light Source and electronics</b></p> <p>8 x LED 4,5 W 350 mA Constant Current 350 mA 110-240V 50/60Hz</p>	<p><b>Packaging</b></p> <p>2 Boxes Total Vol 0,3245 m<sup>3</sup> Gross weight 20,6 Kg Net weight 9,6 Kg</p> <p><b>Notes</b></p> <p>Without pressed-glass diffuser.</p> <p><b>Configuration layout at vibia.com</b> Min. quantity, upcharge and extra lead time apply.</p>
---	--

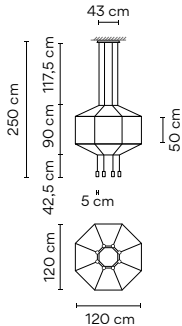

0400



Finishes ● 04/ \_ \_ Black (RAL 9005)  
 LED temperature colour /1\_ 2700 K  CRI >90 3880 lm 121 lm/W

Control 0400 \_ \_ / \_ A DALI-2, 1-10V, Push  
 0400 \_ \_ / \_ Z Casambi

Materials Diffuser: Polycarbonate. Horizontal rods: Steel.  
 Body: Aluminum Canopy: Steel.

Light Source and electronics 8 x LED 4,5 W 350 mA  
 Constant Current 350 mA  
 110-240V 50/60Hz

Packaging 2 Boxes  
 Total Vol 0,3245 m³  
 Gross weight 20,20 Kg Net weight 8,95 Kg

Notes Without pressed-glass diffuser.  
 Configuration layout at [vibia.com](http://vibia.com)  
 Min. quantity, upcharge and extra lead time apply.

UNTIL STOCK RUNS OUT



0401

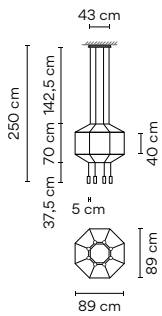

Finishes ● 04/ \_ \_ Black (RAL 9005)  
 LED temperature colour /1\_ 2700 K  CRI >90 3880 lm 121 lm/W

Control 0401 \_ \_ / \_ A DALI-2, 1-10V, Push  
 0401 \_ \_ / \_ Z Casambi

Materials Diffuser: Polycarbonate. Horizontal rods: Steel.  
 Body: Aluminum Canopy: Steel.

Light Source and electronics 8 x LED 4,5 W 350 mA  
 Constant Current 350 mA  
 110-240V 50/60Hz

Packaging 2 Boxes  
 Total Vol 0,2100 m³  
 Gross weight 17,75 Kg Net weight 8,75 Kg

Notes Without pressed-glass diffuser.  
 Configuration layout at [vibia.com](http://vibia.com)  
 Min. quantity, upcharge and extra lead time apply.

UNTIL STOCK RUNS OUT



0402

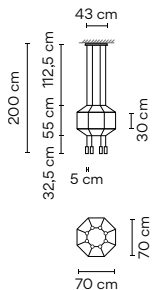

Finishes ● 04/ \_ \_ Black (RAL 9005)  
 LED temperature colour /1\_ 2700 K  CRI >90 3880 lm 121 lm/W

Control 0402 \_ \_ / \_ A DALI-2, 1-10V, Push  
 0402 \_ \_ / \_ Z Casambi

Materials Diffuser: Polycarbonate. Horizontal rods: Steel.  
 Body: Aluminum Canopy: Steel.

Light Source and electronics 8 x LED 4,5 W 350 mA  
 Constant Current 350 mA  
 110-240V 50/60Hz

Packaging 2 Boxes  
 Total Vol 0,1558 m³  
 Gross weight 16,95 Kg Net weight 8,6 Kg

Notes Without pressed-glass diffuser.  
 Configuration layout at [vibia.com](http://vibia.com)  
 Min. quantity, upcharge and extra lead time apply.

UNTIL STOCK RUNS OUT





0403

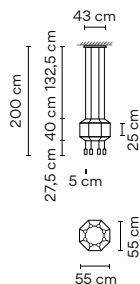

Finishes  
 ● 04/ \_\_ Black (RAL 9005)

LED temperature colour  
 /1\_ 2700 K  CRI >90 3880 lm 121 lm/W

Control  
 0403 \_\_ / \_ A DALI-2, 1-10V, Push

0403 \_\_ / \_ Z Casambi

Materials  
 Diffuser: Polycarbonate. Horizontal rods: Steel.  
 Body: Aluminum Canopy: Steel.

Light Source and electronics  
 8 x LED 4,5 W 350 mA  
 Constant Current 350 mA  
 110-240V 50/60Hz

Packaging  
 2 Boxes  
 Total Vol 0,1558 m<sup>3</sup>  
 Gross weight 16,65 Kg Net weight 8,5 Kg

Notes  
 Without pressed-glass diffuser.

Configuration layout at [vibia.com](http://vibia.com)  
 Min. quantity, upcharge and extra lead time apply.

UNTIL STOCK RUNS OUT



0404

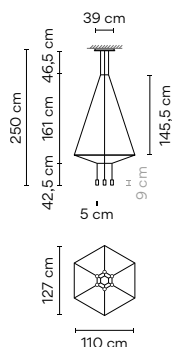

Finishes  
 ● 04/ \_\_ Black (RAL 9005)

LED temperature colour  
 /1\_ 2700 K  CRI >90 2910 lm 121 lm/W

Control  
 0404 \_\_ / \_ A DALI-2, 1-10V, Push

0404 \_\_ / \_ Z Casambi

Materials  
 Diffuser: Polycarbonate. Horizontal rods: Steel.  
 Body: Aluminum Canopy: Steel.

Light Source and electronics  
 6 x LED 4,5 W 350 mA  
 Constant Current 350 mA  
 110-240V 50/60Hz

Packaging  
 2 Boxes  
 Total Vol 0,3245 m<sup>3</sup>  
 Gross weight 15,55 Kg Net weight 5,65 Kg

Notes  
 Without pressed-glass diffuser.

Configuration layout at [vibia.com](http://vibia.com)  
 Min. quantity, upcharge and extra lead time apply.

UNTIL STOCK RUNS OUT



0405

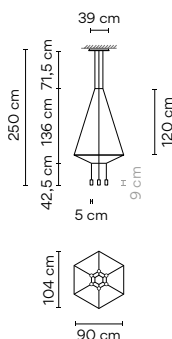

Finishes  
 ● 04/ \_\_ Black (RAL 9005)

LED temperature colour  
 /1\_ 2700 K  CRI >90 2910 lm 121 lm/W

Control  
 0405 \_\_ / \_ A DALI-2, 1-10V, Push

0405 \_\_ / \_ Z Casambi

Materials  
 Diffuser: Polycarbonate. Horizontal rods: Steel.  
 Body: Aluminum Canopy: Steel.

Light Source and electronics  
 6 x LED 4,5 W 350 mA  
 Constant Current 350 mA  
 110-240V 50/60Hz

Packaging  
 2 Boxes  
 Total Vol 0,3245 m<sup>3</sup>  
 Gross weight 15,55 Kg Net weight 5,65 Kg

Notes  
 Without pressed-glass diffuser.

Configuration layout at [vibia.com](http://vibia.com)  
 Min. quantity, upcharge and extra lead time apply.

UNTIL STOCK RUNS OUT



0406

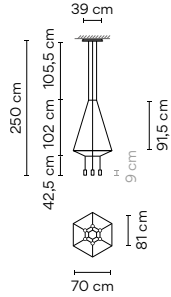

Finishes ● 04/ \_ \_ Black (RAL 9005)  
 LED temperature colour /1\_ 2700 K CRI >90 2910 lm 121 lm/W

Control 0406 \_ \_ / \_ A DALI-2, 1-10V, Push  
 0406 \_ \_ / \_ Z Casambi

Materials Diffuser: Polycarbonate. Horizontal rods: Steel.  
 Body: Aluminum Canopy: Steel.

Light Source and electronics 6 x LED 4,5 W 350 mA  
 Constant Current 350 mA  
 110-240V 50/60Hz

Packaging 2 Boxes  
 Total Vol 0,2100 m³  
 Gross weight 13,1 Kg Net weight 5,2 Kg

Notes Without pressed-glass diffuser.  
 Configuration layout at [vibia.com](http://vibia.com)  
 Min. quantity, upcharge and extra lead time apply.

UNTIL STOCK RUNS OUT



0407

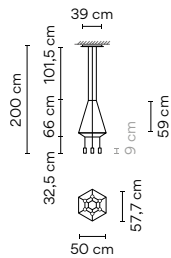

Finishes ● 04/ \_ \_ Black (RAL 9005)  
 LED temperature colour /1\_ 2700 K CRI >90 2910 lm 121 lm/W

Control 0407 \_ \_ / \_ A DALI-2, 1-10V, Push  
 0407 \_ \_ / \_ Z Casambi

Materials Diffuser: Polycarbonate. Horizontal rods: Steel.  
 Body: Aluminum Canopy: Steel.

Light Source and electronics 6 x LED 4,5 W 350 mA  
 Constant Current 350 mA  
 110-240V 50/60Hz

Packaging 2 Boxes  
 Total Vol 0,1558 m³  
 Gross weight 10 Kg Net weight 5,1 Kg

Notes Without pressed-glass diffuser.  
 Configuration layout at [vibia.com](http://vibia.com)  
 Min. quantity, upcharge and extra lead time apply.

UNTIL STOCK RUNS OUT



0408

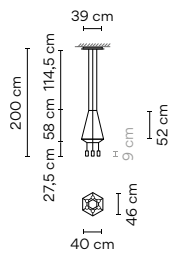

Finishes ● 04/ \_ \_ Black (RAL 9005)  
 LED temperature colour /1\_ 2700 K CRI >90 2910 lm 121 lm/W

Control 0408 \_ \_ / \_ A DALI-2, 1-10V, Push  
 0408 \_ \_ / \_ Z Casambi

Materials Diffuser: Polycarbonate. Horizontal rods: Steel.  
 Body: Aluminum Canopy: Steel.

Light Source and electronics 6 x LED 4,5 W 350 mA  
 Constant Current 350 mA  
 110-240V 50/60Hz

Packaging 2 Boxes  
 Total Vol 0,1238 m³  
 Gross weight 8,4 Kg Net weight 5 Kg

Notes Without pressed-glass diffuser.  
 Configuration layout at [vibia.com](http://vibia.com)  
 Min. quantity, upcharge and extra lead time apply.

UNTIL STOCK RUNS OUT



0409

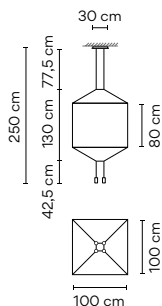

Finishes ● **04/** \_\_ Black (RAL 9005) LED temperature colour /1\_ 2700 K CRI >90 1940 lm 121 lm/W

Control **0409** \_\_ / \_ A DALI-2, 1-10V, Push **0409** \_\_ / \_ Z Casambi

Materials Diffuser: Polycarbonate. Horizontal rods: Steel. Body: Aluminum Canopy: Steel.

Light Source and electronics 4 x LED 4,5 W 350 mA Constant Current 350 mA 110~240V 50/60Hz

Packaging 2 Boxes Total Vol 0,2100 m<sup>3</sup> Gross weight 12,3 Kg Net weight 5,3 Kg

Notes Without pressed-glass diffuser.

Configuration layout at [vibia.com](http://vibia.com) Min. quantity, upcharge and extra lead time apply.

UNTIL STOCK RUNS OUT



0410

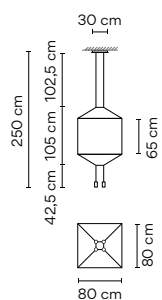

Finishes ● **04/** \_\_ Black (RAL 9005) LED temperature colour /1\_ 2700 K CRI >90 1940 lm 121 lm/W

Control **0410** \_\_ / \_ A DALI-2, 1-10V, Push **0410** \_\_ / \_ Z Casambi

Materials Diffuser: Polycarbonate. Horizontal rods: Steel. Body: Aluminum Canopy: Steel.

Light Source and electronics 4 x LED 4,5 W 350 mA Constant Current 350 mA 110~240V 50/60Hz

Packaging 2 Boxes Total Vol 0,2100 m<sup>3</sup> Gross weight 11,8 Kg Net weight 4,8 Kg

Notes Without pressed-glass diffuser.

Configuration layout at [vibia.com](http://vibia.com) Min. quantity, upcharge and extra lead time apply.

UNTIL STOCK RUNS OUT



0411

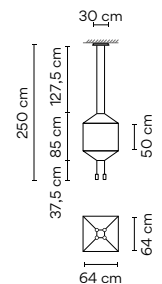

Finishes ● **04/** \_\_ Black (RAL 9005) LED temperature colour /1\_ 2700 K CRI >90 1940 lm 121 lm/W

Control **0411** \_\_ / \_ A DALI-2, 1-10V, Push **0411** \_\_ / \_ Z Casambi

Materials Diffuser: Polycarbonate. Horizontal rods: Steel. Body: Aluminum Canopy: Steel.

Light Source and electronics 4 x LED 4,5 W 350 mA Constant Current 350 mA 110~240V 50/60Hz

Packaging 2 Boxes Total Vol 0,1558 m<sup>3</sup> Gross weight 11,4 Kg Net weight 4,7 Kg

Notes Without pressed-glass diffuser.

Configuration layout at [vibia.com](http://vibia.com) Min. quantity, upcharge and extra lead time apply.

UNTIL STOCK RUNS OUT



0412

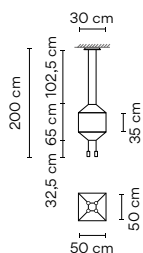

<b>Finishes</b> ● 04/ _ _ Black (RAL 9005)	<b>LED temperature colour</b> /1_ 2700 K  CRI >90 1940 lm 121 lm/W	<b>Control</b> 0412 _ _ / _ A DALI-2, 1-10V, Push 0412 _ _ / _ Z Casambi
---	---	--

**Materials**  
 Diffuser: Polycarbonate. Horizontal rods: Steel.  
 Body: Aluminum Canopy: Steel.

**Light Source and electronics**  
 4 x LED 4,5 W 350 mA  
 Constant Current 350 mA  
 110-240V 50/60Hz

**Packaging**  
 2 Boxes  
 Total Vol 0,1558 m<sup>3</sup>  
 Gross weight 11,2 Kg Net weight 4,6 Kg

**Notes**  
 Without pressed-glass diffuser.  
**Configuration layout at vibia.com**  
 Min. quantity, upcharge and extra lead time apply.

**UNTIL STOCK RUNS OUT**



0413

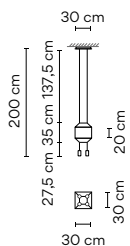

<b>Finishes</b> ● 04/ _ _ Black (RAL 9005)	<b>LED temperature colour</b> /1_ 2700 K  CRI >90 1940 lm 121 lm/W	<b>Control</b> 0413 _ _ / _ A DALI-2, 1-10V, Push 0413 _ _ / _ Z Casambi
---	---	--

**Materials**  
 Diffuser: Polycarbonate. Horizontal rods: Steel.  
 Body: Aluminum Canopy: Steel.

**Light Source and electronics**  
 4 x LED 4,5 W 350 mA  
 Constant Current 350 mA  
 110-240V 50/60Hz

**Packaging**  
 2 Boxes  
 Total Vol 0,1238 m<sup>3</sup>  
 Gross weight 7 Kg Net weight 4,5 Kg

**Notes**  
 Without pressed-glass diffuser.  
**Configuration layout at vibia.com**  
 Min. quantity, upcharge and extra lead time apply.

**UNTIL STOCK RUNS OUT**

